

Dell™ Optiplex™ 960

Setup and Quick Reference Guide

This guide provides a features overview, specifications, and quick setup, software, and troubleshooting information for your computer. For more information about your operating system, devices, and technologies, see the *Dell Technology Guide* at support.dell.com.

Models DCSM, DCNE, DCCY

Notes, Notices, and Cautions



NOTE: A NOTE indicates important information that helps you make better use of your computer.



NOTICE: A NOTICE indicates either potential damage to hardware or loss of data and tells you how to avoid the problem.



CAUTION: A CAUTION indicates a potential for property damage, personal injury, or death.

If you purchased a Dell™ n Series computer, any references in this document to Microsoft® Windows® operating systems are not applicable.

Macrovision Product Notice

This product incorporates copyright protection technology that is protected by method claims of certain U.S. patents and other intellectual property rights owned by Macrovision Corporation and other rights owners. Use of this copyright protection technology must be authorized by Macrovision Corporation, and is intended for home and other limited viewing uses only unless otherwise authorized by Macrovision Corporation. Reverse engineering or disassembly is prohibited.

Information in this document is subject to change without notice.

© 2008 Dell Inc. All rights reserved.

Reproduction of these materials in any manner whatsoever without the written permission of Dell Inc. is strictly forbidden.

Trademarks used in this text: *Dell*, the *DELL* logo, *OptiPlex*, and *DellConnect* are trademarks of Dell Inc.; *Bluetooth* is a registered trademark owned by Bluetooth SIG, Inc., and is used by Dell under license; *Intel*, *Pentium*, *iAMT*, *Core*, and *Celeron* are registered trademarks of Intel Corporation in the U.S. and other countries; *Blu-ray Disc* is a trademark of the Blu-ray Disc Association; *Microsoft*, *Windows*, *Windows Server*, *MS-DOS*, *Windows Vista*, and the *Windows Vista* start button logo are either trademarks or registered trademarks of Microsoft Corporation in the United States and/or other countries; *AMD*, *ATI*, and *ATI Mobility Radeon* are trademarks of Advanced Micro Devices, Inc.

Other trademarks and trade names may be used in this document to refer to either the entities claiming the marks and names or their products. Dell Inc. disclaims any proprietary interest in trademarks and trade names other than its own.

Models DCSM, DCNE, DCCY

August 2008

P/N K080D

Rev. A00

Contents

1	About Your Computer	7
	Mini Tower — Front View	7
	Mini Tower — Back View	8
	Mini Tower — Back Panel Connectors	9
	Desktop — Front View	10
	Desktop — Back View	11
	Desktop — Back Panel Connectors	12
	Small Form Factor— Front View	13
	Small Form Factor— Back View	14
	Small Form Factor— Back Panel Connectors	15
2	Setting Up Your Computer	17
	Quick Setup	17
	Installing Your Computer in an Enclosure	22
	Connecting to the Internet	24
	Setting Up Your Internet Connection	24

	Transferring Information to a New Computer	25
	Microsoft® Windows Vista® Operating System.	25
	Microsoft Windows® XP	25
3	Specifications	29
4	Troubleshooting Tips	39
	Using the Hardware Troubleshooter.	39
	Tips	39
	Power Problems	39
	Memory Problems	47
	Lockups and Software Problems	48
	Dell Technical Update Service	49
	Dell Diagnostics.	49
5	Reinstalling Software	51
	Drivers	51
	Identifying Drivers	51
	Reinstalling Drivers and Utilities	51
	Restoring Your Operating System	53
	Using Microsoft® Windows® System Restore	54
	Using Dell Factory Image Restore	54
	Using the Operating System Media.	55

6	Finding Information	57
7	Getting Help	59
	Obtaining Assistance	59
	Fast Call for Help	60
	Loading iAMT drivers on installation.	60
	Technical Support and Customer Service	61
	DellConnect™	61
	Online Services.	61
	AutoTech Service.	62
	Automated Order-Status Service.	62
	Problems With Your Order.	62
	Product Information	63
	Returning Items for Warranty Repair or Credit	63
	Before You Call	64
	Contacting Dell	66
	 Index	 67

About Your Computer

Mini Tower — Front View

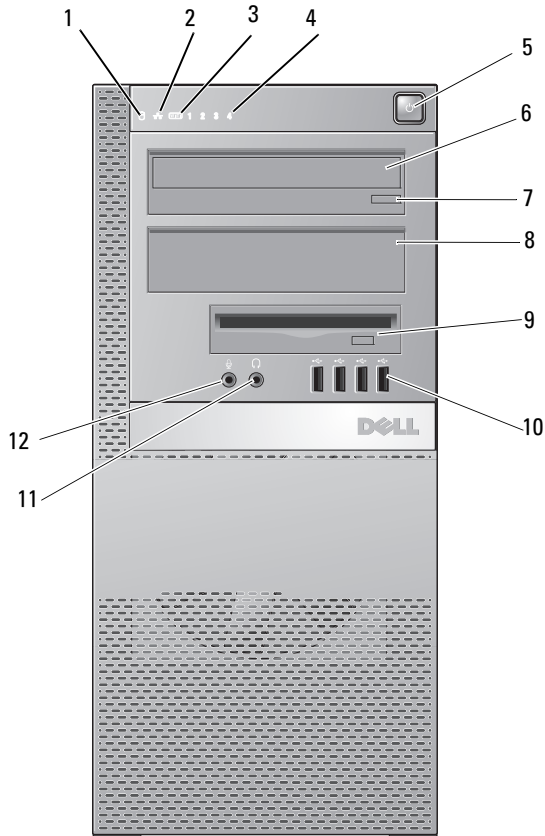

- | | | | |
|---|---------------------------|---|----------------------|
| 1 | hard drive activity light | 2 | link integrity light |
| 3 | WiFi (optional) light | 4 | diagnostic lights |
| 5 | power button, power light | 6 | optical drive |

- 7 optical-drive eject button
- 8 optical-drive filler panel
- 9 flex bay (for optional floppy drive or memory card reader)
- 10 USB 2.0 connectors (4)
- 11 headphone connector
- 12 microphone connector

Mini Tower — Back View

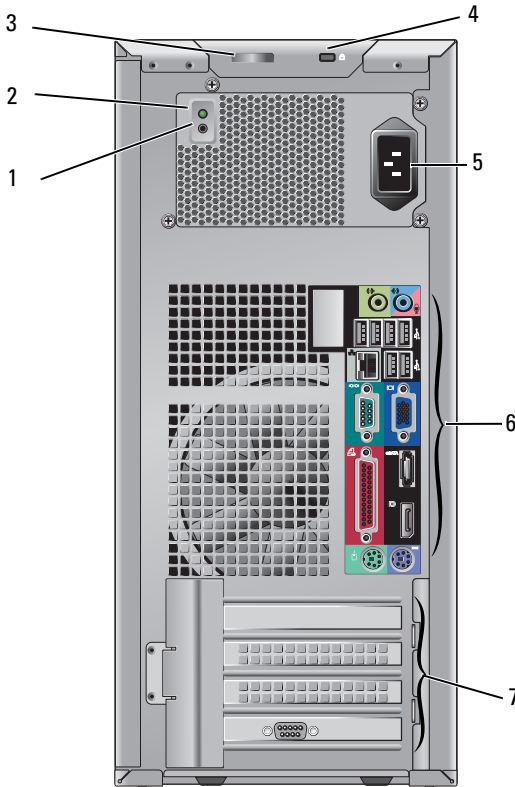

- 1 power supply check button
- 2 power supply check light
- 3 cover-release latch and padlock ring (security screw also an option)
- 4 security cable slot

- 5 power connector
- 6 back-panel connectors
- 7 expansion-card slots (4)

Mini Tower — Back Panel Connectors

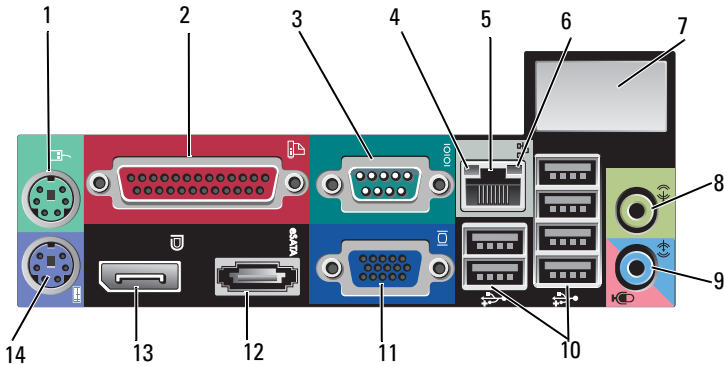

- 1 PS2 mouse connector
- 2 parallel (printer) connector
- 3 serial connector
- 4 network-activity light
- 5 network adapter connector
- 6 link-integrity light
- 7 space for optional wireless connector
- 8 line-out connector
- 9 line-in/microphone connector
- 10 USB 2.0 connectors (6)
- 11 VGA video connector
- 12 eSATA connector
- 13 DisplayPort connector
- 14 PS2 keyboard connector

Desktop — Front View

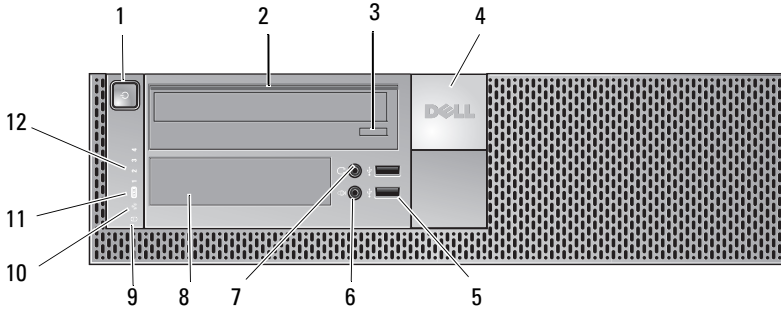

- | | | | |
|----|---------------------------------|----|--|
| 1 | power button, power light | 2 | optical drive |
| 3 | optical-drive tray eject button | 4 | Dell™ badge |
| 5 | USB 2.0 connectors (2) | 6 | microphone connector |
| 7 | headphone connector | 8 | flex bay (for optional floppy drive, memory card reader, or second 3.5-inch hard disk drive) |
| 9 | hard drive activity light | 10 | link integrity light |
| 11 | WiFi (optional) light | 12 | diagnostic lights |

Desktop — Back View

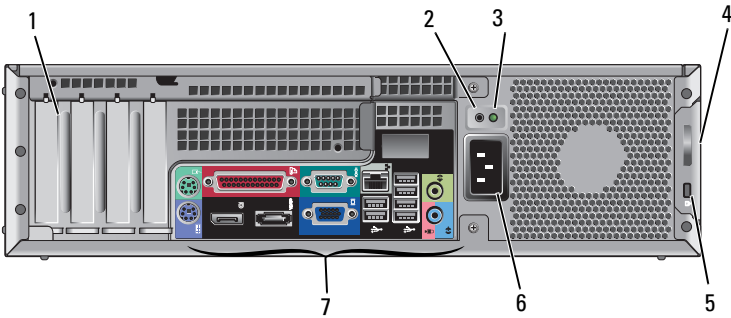

- | | | | |
|---|--------------------------|---|---|
| 1 | expansion card slots (4) | 2 | power supply check button |
| 3 | power supply check light | 4 | cover-release latch and padlock ring
(security screw also an option) |
| 5 | security cable slot | 6 | power connector |
| 7 | back-panel connectors | | |

Desktop — Back Panel Connectors

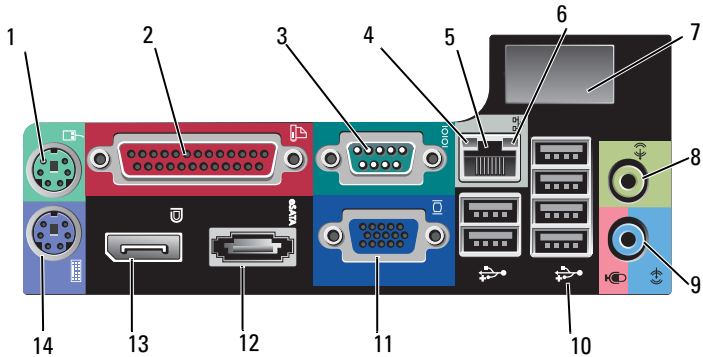

- | | | | |
|----|---------------------------------------|----|------------------------------|
| 1 | PS2 mouse connector | 2 | parallel (printer) connector |
| 3 | serial connector | 4 | network-activity light |
| 5 | network adapter connector | 6 | link-integrity light |
| 7 | space for optional wireless connector | 8 | line-out connector |
| 9 | line-in/microphone connector | 10 | USB 2.0 connectors (6) |
| 11 | VGA video connector | 12 | eSATA connector |
| 13 | DisplayPort connector | 14 | PS2 keyboard connector |

Small Form Factor— Front View

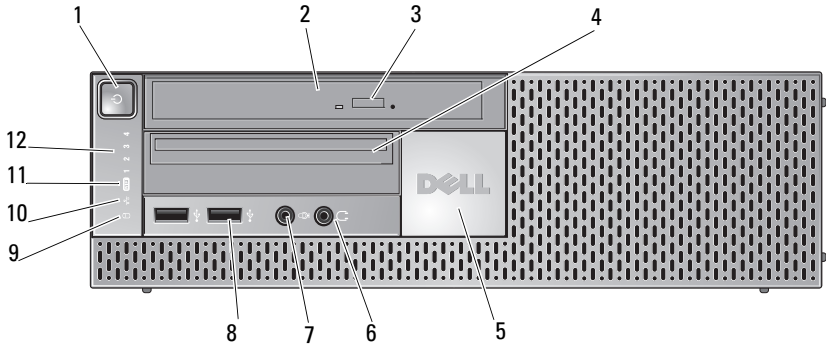

- | | | | |
|----|----------------------------|----|--|
| 1 | power button, power light | 2 | optical-drive (slim-line) |
| 3 | optical-drive eject button | 4 | slim-line flex bay (for optional floppy drive or memory card reader) |
| 5 | Dell badge | 6 | headphone connector |
| 7 | microphone connector | 8 | USB 2.0 connectors (2) |
| 9 | hard drive activity light | 10 | link integrity light |
| 11 | WiFi (optional) light | 12 | diagnostic lights |

Small Form Factor— Back View

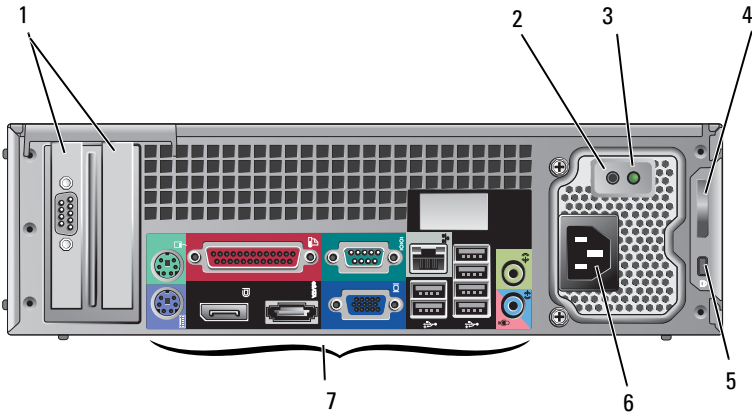

- 1 expansion-card slots (2)
- 2 power supply check button
- 3 power supply check light
- 4 cover-release latch and padlock ring (security screw also an option)
- 5 security cable slot
- 6 power connector
- 7 back-panel connectors

Small Form Factor— Back Panel Connectors

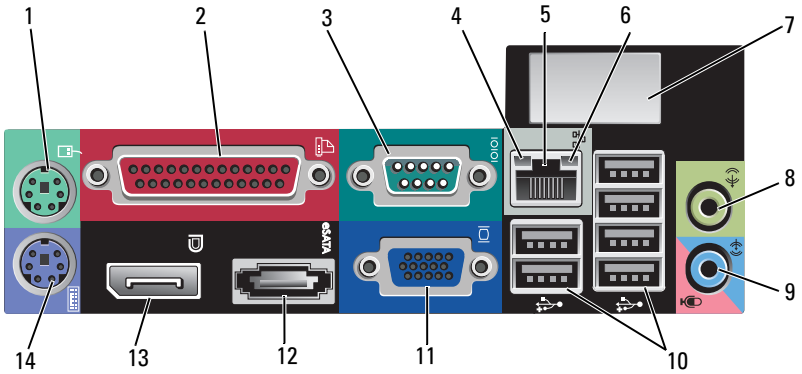

- | | | | |
|----|---------------------------------------|----|------------------------------|
| 1 | PS2 mouse connector | 2 | parallel (printer) connector |
| 3 | serial connector | 4 | network-activity light |
| 5 | network adapter connector | 6 | link-integrity light |
| 7 | space for optional wireless connector | 8 | line-out connector |
| 9 | line-in/microphone connector | 10 | USB 2.0 connectors (6) |
| 11 | VGA video connector | 12 | eSATA connector |
| 13 | DisplayPort connector | 14 | PS2 keyboard connector |

Setting Up Your Computer

Quick Setup

! **CAUTION:** Before you begin any of the procedures in this section, follow the safety instructions that shipped with your computer.

✍ **NOTE:** Some devices may not be included if you did not order them.

- 1 Your computer comes with VGA and DisplayPort connectors for video (Desktop back panel shown here).

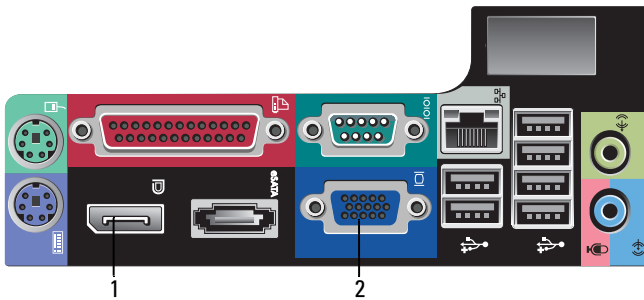

1 DisplayPort connector

2 VGA video connector

- 2 Using the DisplayPort for video may require an optional adapter to connect to older monitors which only support VGA and/or DVI (available at www.dell.com). Refer to the Dell Technology Guide for more information about DisplayPort.

✍ **NOTE:** When connecting a DisplayPort monitor or adapter, the multi-monitor capability of the system will not be available during boot or when running DOS. Output will be limited to the DisplayPort monitor only. When the system has booted to Windows and loaded the graphics driver, then multi-monitor support will be fully functional.

 **NOTE:** Connection of a DisplayPort monitor or adapter will result in the x16 PCI-Express slot being disabled. This is not a valid configuration. Remove the PCI-Express card. Alternatively you may use the VGA port to connect a display device if the PCI-Express card is not a graphics card.

3 Connect the monitor using a VGA cable.

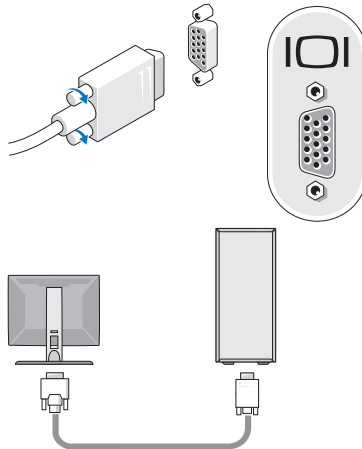

4 Connect a USB device, such as a keyboard or mouse.

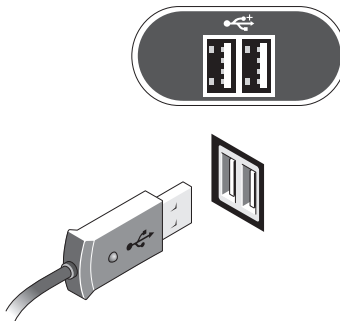

5 Connect the network cable.

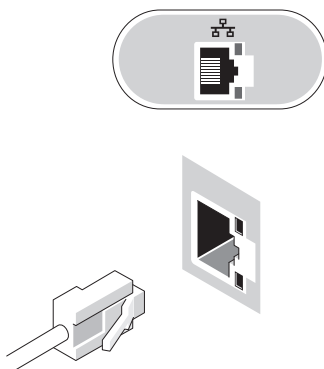

6 Connect the modem (if your computer has this option).

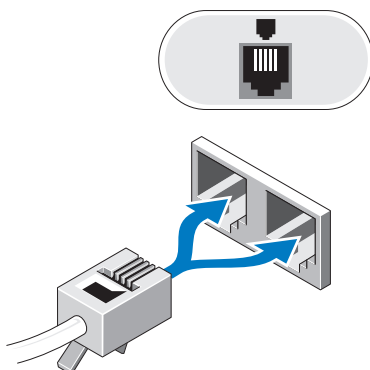

7 Connect the power cable(s).

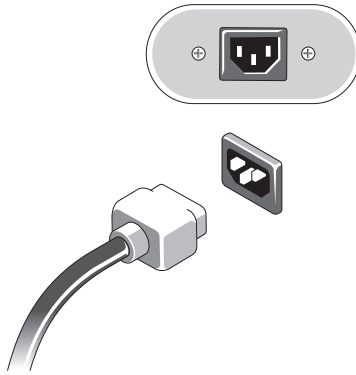

8 Press the power buttons on the monitor and the computer.

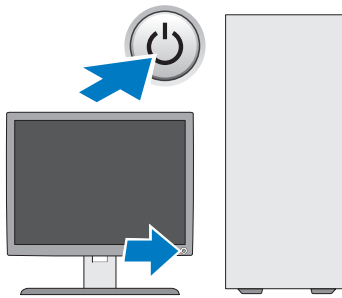

9 Connect to your network.

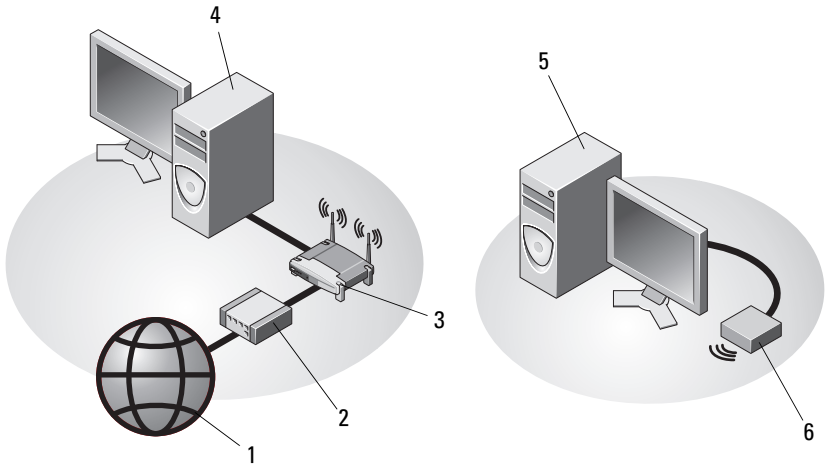

- | | | | |
|---|---|---|---------------------------------------|
| 1 | Internet service | 2 | cable or DSL modem |
| 3 | wireless router (not necessary if your computer has the optional WiFi capability) | 4 | desktop computer with network adapter |
| 5 | desktop computer with USB wireless | 6 | USB wireless adapter |

The Dell™ Wireless Antenna, if purchased, connects to the wireless connector.

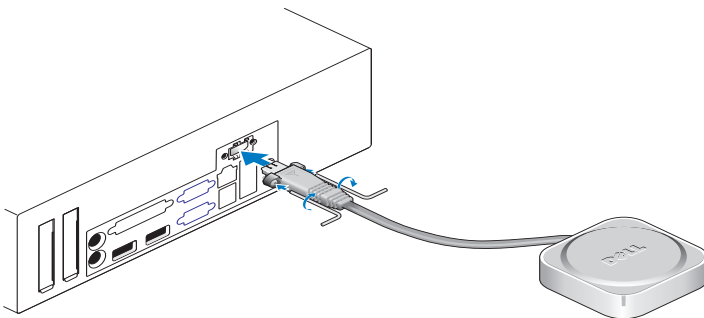



NOTE: For security, the Wireless Antenna uses special screws to connect to the system that can only be removed using the key provided in the kit. The screws do not need to be attached for the wireless antenna to function.

Installing Your Computer in an Enclosure

Installing your computer in an enclosure can restrict the airflow and impact your computer's performance, possibly causing it to overheat. Follow the guidelines below when installing your computer in an enclosure.



CAUTION: Before installing your computer in an enclosure, read the safety instructions that shipped with your computer.



NOTICE: The operating temperature specifications indicated in this document reflect the maximum ambient operating temperature. The room's ambient temperature needs to be a consideration when installing your system in an enclosure. For example, if the ambient room temperature is at 25° C (77° F), depending on your system's specifications, you may only have 10° C (18° F) before you reach your system's maximum operating temperature. For details about your computer's specifications, see "Specifications" on page 29.

- Leave a 10.2-cm (4-in) minimum clearance on all sides of the computer that have air vents to permit the airflow required for proper ventilation.

Non-ventilated sides of the system can be placed close to the sides of the enclosure. However, for acoustic and vibration optimization, the system sides should not touch the enclosure unless there are isolating features present. These isolation features are typically only on the bottom of a system, however, on some systems, an additional side has these isolation features.

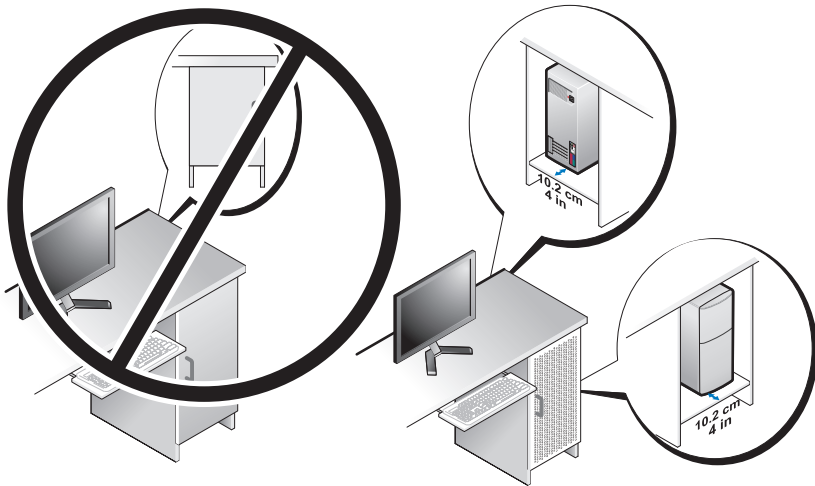

- The enclosure should be designed so that the ambient air entering the system meets the operating temperature requirements of the system. The enclosure design should be designed to minimize the temperature increase of the air entering the system by:
 - Implementing enclosure venting that allows at least 30% airflow (front and back)
 - Implementing enclosure ventilation that aligns well with the system ventilation to allow direct airflow into the system. This is especially important at the exhaust of the system.
 - Ensuring that there is ventilation at the highest point of the enclosure (such as a gap between the door and top of the enclosure) to allow hot air to escape.
- ➔ **NOTICE:** Do not install your computer in an enclosure that does not allow airflow. Restricting the airflow impacts your computer's performance, possibly causing it to overheat.
- If your computer is installed in a corner on a desk or under a desk, leave at least 5.1-cm (2-in) clearance from the front of the computer and at least 5.1 cm (2 in) from the back of the computer to the wall to permit the airflow required for proper ventilation.

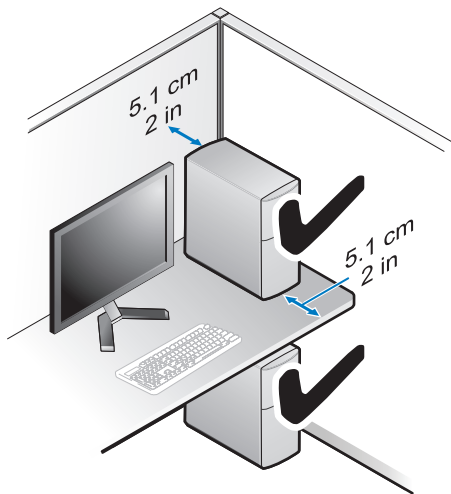

Connecting to the Internet

 **NOTE:** ISPs and ISP offerings vary by country.

To connect to the Internet, you need a modem or network connection and an Internet service provider (ISP). *If you are using a dial-up connection*, connect a telephone line to the modem connector on your computer and to the telephone wall connector before you set up your Internet connection. *If you are using a DSL or cable/satellite modem connection*, contact your ISP or cellular phone service for setup instructions.

Setting Up Your Internet Connection

To set up an Internet connection with a desktop shortcut provided by your ISP:

- 1 Save and close any open files, and exit any open programs.
- 2 Double-click the ISP icon on the Microsoft® Windows® desktop.
- 3 Follow the instructions on the screen to complete the setup.

If you do not have an ISP icon on your desktop or if you want to set up an Internet connection with a different ISP, perform the steps in the appropriate section below.

 **NOTE:** If you cannot connect to the Internet, see the *Dell Technology Guide*. If you have successfully connected in the past, the ISP might have a service outage. Contact your ISP to check the service status, or try connecting again later.

 **NOTE:** Have your ISP information ready. If you do not have an ISP, consult the **Connect to the Internet** wizard.

- 1 Save and close any open files, and exit any open programs.
- 2 Click the Windows Vista Start button  → **Control Panel**
- 3 Under **Network and Internet**, click **Connect to the Internet**.
- 4 In the **Connect to the Internet** window, click either **Broadband (PPPoE)** or **Dial-up**, depending on how you want to connect:
 - Choose **Broadband** if you will use a DSL, satellite modem, cable TV modem, or Bluetooth wireless technology connection.
 - Chose **Dial-up** if you will use a dial-up modem or ISDN.

 **NOTE:** If you do not know which type of connection to select, click **Help me choose** or contact your ISP.

- 5 Follow the instructions on the screen and use the setup information provided by your ISP to complete the setup.

Transferring Information to a New Computer

Microsoft® Windows Vista® Operating System

- 1 Click the Windows Vista Start button , and then click **Transfer files and settings** → **Start Windows Easy Transfer**.
- 2 In the **User Account Control** dialog box, click **Continue**.
- 3 Click **Start a new transfer** or **Continue a transfer in progress**.
- 4 Follow the instructions provided on the screen by the Windows Easy Transfer wizard.

Microsoft Windows® XP

Windows XP provides the Files and Settings Transfer Wizard to move data from a source computer to a new computer.

You can transfer the data to the new computer over a network or serial connection, or you can store it on removable media, such as a writable CD, for transfer to the new computer.



NOTE: You can transfer information from an old computer to a new computer by directly connecting a serial cable to the input/output (I/O) ports of the two computers.

For instructions on setting up a direct cable connection between two computers, see Microsoft Knowledge Base Article #305621, titled *How to Set Up a Direct Cable Connection Between Two Computers in Windows XP*. This information may not be available in certain countries.

For transferring information to a new computer, you must run the Files and Settings Transfer Wizard.

Running the Files and Settings Transfer Wizard With the Operating System Media



NOTE: This procedure requires the *Operating System* media. This media is optional and may not be included with certain computers.

To prepare a new computer for the file transfer:

- 1 Open the Files and Settings Transfer Wizard: click **Start**→ **All Programs**→ **Accessories**→ **System Tools**→ **Files and Settings Transfer Wizard**.
- 2 When the **Files and Settings Transfer Wizard** welcome screen appears, click **Next**.
- 3 On the **Which computer is this?** screen, click **New Computer**→ **Next**.
- 4 On the **Do you have a Windows XP CD?** screen, click **I will use the wizard from the Windows XP CD**→ **Next**.
- 5 When the **Now go to your old computer** screen appears, go to your old or source computer. Do *not* click **Next** at this time.

To copy data from the old computer:

- 1 On the old computer, insert the Windows XP *Operating System* media.
- 2 On the **Welcome to Microsoft Windows XP** screen, click **Perform additional tasks**.
- 3 Under **What do you want to do?**, click **Transfer files and settings**→ **Next**.
- 4 On the **Which computer is this?** screen, click **Old Computer**→ **Next**.
- 5 On the **Select a transfer method** screen, click the transfer method you prefer.

- 6 On the **What do you want to transfer?** screen, select the items you want to transfer and click **Next**.

After the information has been copied, the **Completing the Collection Phase** screen appears.

- 7 Click **Finish**.

To transfer data to the new computer:

- 1 On the **Now go to your old computer** screen on the new computer, click **Next**.
- 2 On the **Where are the files and settings?** screen, select the method you chose for transferring your settings and files and click **Next**.

The wizard applies the collected files and settings to your new computer.

- 3 On the **Finished** screen, click **Finished**, and restart the new computer.

Running the Files and Settings Transfer Wizard Without the Operating System Media

To run the Files and Settings Transfer Wizard without the *Operating System* media, you must create a wizard disk that will allow you to create a backup image file to removable media.

To create a wizard disk, use your new computer with Windows XP and perform the following steps:

- 1 Open the Files and Settings Transfer Wizard: click **Start**→ **All Programs**→ **Accessories**→ **System Tools**→ **Files and Settings Transfer Wizard**.
- 2 When the **Files and Settings Transfer Wizard** welcome screen appears, click **Next**.
- 3 On the **Which computer is this?** screen, click **New Computer**→ **Next**.
- 4 On the **Do you have a Windows XP CD?** screen, click **I want to create a Wizard Disk in the following drive**→ **Next**.
- 5 Insert the removable media, such as a writable CD, and click **OK**.
- 6 When the disk creation completes and the **Now go to your old computer** message appears, *do not* click **Next**.
- 7 Go to the old computer.

To copy data from the old computer:

- 1 On the old computer, insert the wizard disk, and click **Start**→**Run**.
- 2 In the **Open** field on the **Run** window, browse to the path for **fastwiz** (on the appropriate removable media) and click **OK**.
- 3 On the **Files and Settings Transfer Wizard** welcome screen, click **Next**.
- 4 On the **Which computer is this?** screen, click **Old Computer**→**Next**.
- 5 On the **Select a transfer method** screen, click the transfer method you prefer.
- 6 On the **What do you want to transfer?** screen, select the items you want to transfer and click **Next**.

After the information has been copied, the **Completing the Collection Phase** screen appears.

- 7 Click **Finish**.

To transfer data to the new computer:

- 1 On the **Now go to your old computer** screen on the new computer, click **Next**.
- 2 On the **Where are the files and settings?** screen, select the method you chose for transferring your settings and files and click **Next**. Follow the instructions on the screen.

The wizard reads the collected files and settings and applies them to your new computer.

When all of the settings and files have been applied, the **Finished** screen appears.

- 3 Click **Finished** and restart the new computer.



NOTE: For more information about this procedure, search support.dell.com for document #154781 (*What Are The Different Methods To Transfer Files From My Old Computer To My New Dell™ Computer Using the Microsoft® Windows® XP Operating System?*).



NOTE: Access to the Dell™ Knowledge Base document may not be available in certain countries.

Specifications



NOTE: Offerings may vary by region. For more information regarding the configuration of your computer, click **Start**→ **Help and Support** and select the option to view information about your computer.

Processor

Processor type	Intel® Core™ 2 Quad Processor FSB up to 1333 MHz Intel® Core™ 2 Duo Desktop Processor Intel® Pentium® Dual-Core Desktop Processor Intel® Celeron® Processor Family 440
----------------	---

System Information

Chipset	Intel® Q45 Express chipset
RAID Support	RAID 1 (Mirroring) RAID 0 (Striping), and Intel® Rapid Recovery Technology (IRRT)
DMA channels	seven
Interrupt levels	24
BIOS chip (NVRAM)	8 MB
NIC	Intel® 82567, integrated network interface capable of 10/100/1000 communication

Memory

Type	667 MHz or 800 MHz DDR2 SDRAM
Memory connectors	four

Memory (continued)

Memory capacities

667 MHz	512 MB, 1 GB, 2 GB, 3 GB, 4 GB, 8 GB NOTE: 512 MB DIMMS are available for use only in the 667-MHz memory configurations.
800 MHz	1 GB, 2 GB, 3 GB, 4 GB, 8 GB
Minimum memory	512 MB for 667 MHz, 1 GB for 800 MHz
Maximum memory	8 GB

Video

Type:

Integrated	Intel® Q45 Graphics Controller up to 1759 MB video memory (shared)
Discrete	ATI Mobility Radeon™ HD3450 256M ATI Mobility Radeon™ HD3470 256M NOTE: Support for discrete full-height video cards is available on Mini Tower and Desktop via PCIe x16 graphics card slot. Support for half-height video cards is available on Desktop and Small Form Factor via PCIe x16 graphics card slot.

Audio

Type	Analog Devices ADI 1984A Integrated HD Audio
------	--

Expansion Bus

Bus type	PCI 2.3 PCI Express 1.0A and 2.0 SATA 1.0 and 2.0 USB 2.0
----------	--

Expansion Bus (continued)

Bus speed	x1-slot bidirectional speed — 500 MB/s (PCI Express) x16-slot bidirectional speed — 16 GB (PCI Express) 1.5 Gbps and 3.0 Gbps (SATA) 480-Mbps high speed, 12-Mbps full speed, 1.2-Mbps low speed (USB)
Expansion card slots	
connectors	Mini Tower: four full-height slots Desktop: four half-height slots without riser, two full-height slots, two half-height slots with riser Small Form Factor: two half-height slots
PCI	Mini Tower: two connectors Desktop: two low-profile connectors, with support for two full-height 6.9-in PCI cards (or one 6.9-in PCI and one 6.9-in PCIe x16 card) if a PCI riser board is used Small Form Factor: one connector
connector size	124 pins
connector data width (maximum)	32 bits
PCI Express	NOTE: When using the built-in DisplayPort connector, the x16 PCI Express slot is disabled.
connector	Mini Tower and Desktop: one x16 connector and one x1 connector Small Form Factor: one x16 connector
connector size	x16: 164 pins x1 36 pins
connector data width (maximum)	16 PCI Express lanes (x16)

Expansion Bus (continued)

PCIe_WLS

connector	one x1 (available in all platforms)
connector size	36 pins
use	for optional wireless and WLAN cards

Drives

Hard Disk Drives Mini Tower: two 3.5-inch hard disk drives (HDDs) or two 2.5-inch HDDs

Desktop: two 3.5-inch HDDs or two 2.5-inch HDDs

Small Form Factor: one 3.5-inch HDD or two 2.5-inch HDDs

Available device configurations

Mini Tower: two external 5.25-inch bays, one external 3.5-inch bay, two internal 3.5-inch bays

Desktop: one external 5.25-inch bay, one external 3.5-inch bay, one internal 3.5-inch bay

NOTE: The desktop platform can accommodate two 3.5-inch HDDs, provided no floppy drive is used.

NOTE: The desktop platform will use the external 3.5-inch bay as an internal 3.5-inch HDD for RAID configurations.

Small Form Factor: one external 5.25-inch slimline bay, one external 3.5-inch slimline bay, one internal 3.5-inch bay

NOTE: The number of hard disk drives supported is determined by the number of internal 3.5-inch bays.

NOTE: The optical drives (CD, DVD) is determined by the number of external 5.25-inch bays.

Floppy drive

Mini Tower and Desktop: one 34-pin connector

Small Form Factor: one 38-pin low-profile connector

Connectors

External connectors:

Video	VGA and DisplayPort connectors
Network adapter	RJ-45 connector
USB 2.0-compliant connectors	Mini Tower: four front-panel, and six back-panel USB connectors Desktop: two front-panel, and six back-panel USB connectors Small Form Factor: two front-panel, and six back-panel USB connectors
Audio	front panel: one microphone and one headphone connector; (available in all platforms) back panel: one line-out connector and one line-in/microphone connector (available in all platforms)
eSATA	one eSATA connector (available in all platforms)
Serial	one 9-pin connector; 16550 C-compatible (available in all platforms)
PS/2	one mouse connector and one keyboard connector (available in all platforms)
Parallel	one 25-pin connector (bidirectional, available in all platforms)

System board connectors:

SATA	Mini Tower: four 7-pin connectors Desktop: three 7-pin connectors Small Form Factor: three 7-pin connectors
Internal USB device	media card reader (available in all platforms)
Floppy drive	one 34-pin connector in Mini Tower and Desktop
Processor fan	Mini Tower and Desktop: one five-pin connector Small Form Factor: one five-pin connector and one four-pin connector

Connectors (continued)

Expansion slots	Mini Tower: four full-height slots Desktop: four half-height slots without riser, two full-height slots, two half-height slots with riser Small Form Factor: two half-height slots
PCI Express	Mini Tower and Desktop: one x16 connector and one x1 connector Small Form Factor: one x16 connector
Front panel USB	Mini Tower: two 10-pin connectors Desktop: one 10-pin connectors Small Form Factor: one 10-pin connectors
Processor	one 775-pin connector
Front panel control	one 10-pin connector
Front panel audio HDA header	one 10-pin connector
Memory	four 240-pin connectors
Power 12 V	one 4-pin connector
Power	one 24-pin connector
LAN on motherboard (LOM)	through RJ-45 connector on back panel

Controls and Lights

Front of computer:

Power button	push button
Power light	blue light — Blinking blue in sleep state; solid blue for power-on state amber light — A boot failure has occurred. See "Power Problems" on page 39.
Drive activity light	blue light — A blinking blue light indicates the computer is reading data from or writing data to the SATA hard drive or CD/DVD.
Diagnostic light	amber

Controls and Lights (continued)

Network link light	blue
WiFi (optional) link light	blue
Rear of computer:	
Power supply light	solid green — The power supply is turned on and is functional. The power cable must be connected to the power connector (on back of the computer) and the electrical outlet. A test button and LED are on the side of the unit where the AC plug is located. Customers can test the health of the power system by pressing the test button. When the system's power supply voltage are within specification, the self-test LED lights. If the LED does not light up, the power supply may be defective. AC power must be connected during this test.
Link integrity light (on integrated network adapter)	link integrity light color is based on the link speed: 10 - Green, 100 - Orange, 1000 - Amber/Yellow off (no light) — The computer is not detecting a physical connection to the network.
Network activity light (on integrated network adapter)	yellow blinking light

Power

AC - DC power supply

Wattage	Mini Tower: 305 W Desktop: 255 W Small Form Factor: 235 W
Maximum heat dissipation (MHD) wattage	Mini Tower: 165 W Desktop: 140 W Small Form Factor: 127 W

NOTE: Heat dissipation is calculated by using the power supply wattage rating.

Power

Input voltage (see the safety information that shipped with your computer for important voltage setting information)	115/230 VAC
Input frequency	50/60 Hz
Input amperage	Mini Tower: 3.6 A/1.8 A Desktop: 4.0 A/2.0 A Small Form Factor: 3.5 A/1.8 A
Coin-cell battery	CR2032 lithium coin cell

Physical

Mini Tower

Height	40.8 cm (16.06 in)
Width	18.7 cm (7.36 in)
Depth	43.1 cm (16.96 in)
Weight	at least 11.5 kg (25.3 lbs)

Desktop

Height	39.7 cm (15.61 in)
Width	10.9 cm (4.30 in)
Depth	34.8 cm (13.70 in)
Weight	at least 7.5 kg (16.5 lbs)

Small Form Factor

Height	29.0 cm (11.40 in)
Width	8.5 cm (3.35 in)
Depth	32.4 cm (12.74 in)
Weight	at least 5.9 kg (13.0 lbs)

Environmental

Temperature:

Operating	10° to 35°C (50° to 95°F)
Storage	-40° to 65°C (-40° to 149°F)

Relative humidity 20% to 80% (noncondensing)

Maximum vibration:

Operating	5 to 350 Hz at 0.0002 G ² /Hz
Storage	5 to 500 Hz at 0.001 to 0.01 G ² /Hz

Maximum shock:

Operating	40 G +/- 5% with pulse duration of 2 msec +/- 10% (equivalent to 20 in/sec [51 cm/sec])
Storage	105 G +/- 5% with pulse duration of 2 msec +/- 10% (equivalent to 50 in/sec [127 cm/sec])

Altitude:

Operating	-15.2 to 3048 m (-50 to 10,000 ft)
Storage	-15.2 to 10,668 m (-50 to 35,000 ft)

Airborne contaminant level G2 or lower as defined by ISA-S71.04-1985

Troubleshooting Tips



CAUTION: Always unplug your computer from the electrical outlet before opening the cover.



NOTE: For detailed troubleshooting information, including responding to system messages, see your *Service Manual* on support.dell.com.

Using the Hardware Troubleshooter

- 1 Click the Windows Vista Start button , and click **Help and Support**.
- 2 Type `hardware troubleshooter` in the search field and press <Enter> to start the search.
- 3 In the search results, select the option that best describes the problem and follow the remaining troubleshooting steps.

Tips

- If a device does not work, ensure that the device is properly connected.
- If you added or removed a part before the problem started, review the installation procedures and ensure that the part is correctly installed.
- If an error message appears on the screen, write down the exact message. This message may help support personnel to diagnose and fix the problem(s).
- If an error message occurs in a program, see the program documentation.





Power Problems











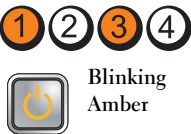

CAUTION: Before working inside your computer, read the safety information that shipped with your computer. For additional safety best practices information, see www.dell.com/regulatory_compliance.





The diagnostic lights on the front of the computer along with the status of the power button indicate the potential problem with the system. Consult the following table in case of a power problem.











 **NOTE:** The diagnostic lights will blink when the power button is amber or off, and will not when it is blue. This has no other significance.



Light Pattern	Problem Description	Suggested Resolution
  Off	The computer is either turned off or not receiving power.	<ul style="list-style-type: none">• Reseat the power cable in the power connector on the back of the computer and the electrical outlet.• Bypass power strips, power extension cables, and other power protection devices to verify that the computer turns on properly.• Ensure that any power strips being used are plugged into an electrical outlet and are turned on.• Ensure that the electrical outlet is working by testing it with another device, such as a lamp.• Ensure that the main power cable and front panel cable are securely connected to the system board.
  Off	A possible motherboard failure has occurred.	<ul style="list-style-type: none">• Unplug the computer. Allow one minute for the power to drain. Plug the computer into a working electrical outlet and press the power button.• If the problem persists, contact Dell (see "Contacting Dell" on page 66).



Light Pattern	Problem Description	Suggested Resolution
	<p>A possible motherboard, power supply, or peripheral failure has occurred.</p>	<ol style="list-style-type: none"> 1 Power off computer, leaving the computer plugged in. Press and hold the power supply test button on the rear of the power supply unit. If the LED next to the switch illuminates, the problem may be with your motherboard. Contact Dell (see "Contacting Dell" on page 66). 2 If the LED next to the switch does not illuminate, disconnect all internal and external peripherals, and press and hold the power supply test button. If it illuminates, there could be a problem with a peripheral. Contact Dell (see "Contacting Dell" on page 66). 3 If the LED still does not illuminate, remove the PSU connections from the motherboard, then press and hold the power supply button. If it illuminates, there could be a problem with the motherboard. Contact Dell (see "Contacting Dell" on page 66). 4 If the LED still does not illuminate, the problem is probably with the power supply. Contact Dell (see "Contacting Dell" on page 66).
	<p>No CPU present.</p>	<ul style="list-style-type: none"> • Reinstall the CPU and restart the system. If the computer still fails to boot, inspect the CPU socket for damage. • If the problem persists, contact Dell (see "Contacting Dell" on page 66).

Light Pattern	Problem Description	Suggested Resolution
  Steady Amber	Memory modules are detected, but a memory power failure has occurred.	<ul style="list-style-type: none"> • If two or more memory modules are installed, remove the modules, then reinstall one module and restart the computer. If the computer starts normally, continue to install additional memory modules (one at a time) until you have identified a faulty module or reinstalled all modules without error. If only one memory module is installed, try moving it to a different DIMM connector and restart the computer. • If available, install verified working memory of the same type into your computer. • If the problem persists, contact Dell (see "Contacting Dell" on page 66).
  Steady Amber	A possible CPU or motherboard failure has occurred.	<ul style="list-style-type: none"> • Replace the CPU with a known good CPU. If the computer still fails to boot, inspect the CPU socket for damage. • If the problem persists, contact Dell (see "Contacting Dell" on page 66).
  Steady Amber	BIOS may be corrupt or missing.	<ul style="list-style-type: none"> • The computer hardware is operating normally but the BIOS may be corrupt or missing. Contact Dell (see "Contacting Dell" on page 66).
  Steady Amber	A possible motherboard failure has occurred.	<ul style="list-style-type: none"> • Remove all peripheral cards from the PCI and PCI-E slots and restart the computer. If the computer boots, add the peripheral cards back one by one until you find the bad one. • If the problem persists, the motherboard is probably bad. Contact Dell (see "Contacting Dell" on page 66).

Light Pattern	Problem Description	Suggested Resolution
 <p>Steady Amber</p>	Power connector not installed properly.	<ul style="list-style-type: none"> Reseat the 2x2 power connector from the power supply unit. If the system still fails to boot, contact Dell (see "Contacting Dell" on page 66).
 <p>Steady Amber</p>	Possible peripheral card or motherboard failure has occurred.	<ul style="list-style-type: none"> Remove all peripheral cards from the PCI and PCI-E slots and restart the computer. If the computer boots, add the peripheral cards back one by one until you find the bad one. If the problem persists, the motherboard is probably bad. Contact Dell (see "Contacting Dell" on page 66).
 <p>Steady Amber</p>	A possible motherboard failure has occurred.	<ul style="list-style-type: none"> Disconnect all internal and external peripherals, and restart the computer. If the computer boots, add the peripheral cards back one by one until you find the bad one. "Contacting Dell" on page 66. If the problem persists, the motherboard is probably bad. Contact Dell (see "Contacting Dell" on page 66).
 <p>Steady Amber</p>	A possible coin cell battery failure has occurred.	<ul style="list-style-type: none"> Remove the coin cell battery for one minute, reinstall the battery, and restart. If the problem persists, contact Dell (see "Contacting Dell" on page 66).
 <p>Steady Blue</p>	<p>The computer is in a normal <i>on</i> condition.</p> <p>The diagnostic lights are not lit after the computer successfully boots to the operating system.</p>	<ul style="list-style-type: none"> Ensure that the display is connected and powered on. If the problem persists, contact Dell (see "Contacting Dell" on page 66).

Light Pattern	Problem Description	Suggested Resolution
  Steady Blue	<p>A possible processor failure has occurred.</p>	<ul style="list-style-type: none"> • Reseat the processor (see Processor information for your computer). • If the problem persists, contact Dell (see "Contacting Dell" on page 66).
  Steady Blue	<p>Memory modules are detected, but a memory failure has occurred.</p>	<ul style="list-style-type: none"> • If two or more memory modules are installed, remove the modules (see your service manual), then reinstall one module (see your service manual and restart the computer. If the computer starts normally, continue to install additional memory modules (one at a time) until you have identified a faulty module or reinstalled all modules without error. • If available, install working memory of the same type into your computer (see your service manual). • If the problem persists, contact Dell (see "Contacting Dell" on page 66).
  Steady Blue	<p>A possible graphics card failure has occurred.</p>	<ul style="list-style-type: none"> • Reseat any installed graphics cards (see the "Cards" section for your computer). • If available, install a working graphics card into your computer. • If the problem persists, contact Dell (see "Contacting Dell" on page 66).
  Steady Blue	<p>A possible floppy drive or hard drive failure has occurred.</p>	<p>Reseat all power and data cables.</p>
  Steady Blue	<p>A possible USB failure has occurred.</p>	<p>Reinstall all USB devices and check all cable connections.</p>

Light Pattern	Problem Description	Suggested Resolution
 <p>Steady Blue</p>	<p>No memory modules are detected.</p>	<ul style="list-style-type: none"> • If two or more memory modules are installed, remove the modules (see your service manual), then reinstall one module (see your service manual) and restart the computer. If the computer starts normally, continue to install additional memory modules (one at a time) until you have identified a faulty module or reinstalled all modules without error. • If available, install working memory of the same type into your computer (see your service manual). • If the problem persists, contact Dell (see "Contacting Dell" on page 66).
 <p>Steady Blue</p>	<p>Memory modules are detected, but a memory configuration or compatibility error has occurred.</p>	<ul style="list-style-type: none"> • Ensure that no special requirements for memory module/connector placement exist. • Ensure that the memory you are using is supported by your computer (see the "Specifications" section for your computer). • If the problem persists, contact Dell (see "Contacting Dell" on page 66).

Light Pattern	Problem Description	Suggested Resolution
 <p>Steady Blue</p>	<p>A possible expansion card failure has occurred.</p>	<ol style="list-style-type: none"> 1 Determine if a conflict exists by removing an expansion card (not a graphics card) and restarting the computer (see the "Cards" section for your computer). 2 If the problem persists, reinstall the card you removed, then remove a different card and restart the computer. 3 Repeat this process for each expansion card installed. If the computer starts normally, troubleshoot the last card removed from the computer for resource conflicts. 4 If the problem persists, contact Dell (see "Contacting Dell" on page 66).
 <p>Steady Blue</p>	<p>Another failure has occurred.</p>	<ul style="list-style-type: none"> • Ensure that all hard drive and optical drive cables are properly connected to the system board (see the "System Board Components" section for your computer). • If there is an error message on the screen identifying a problem with a device (such as the floppy drive or hard drive), check the device to make sure it is functioning properly. • If the operating system is attempting to boot from a device (such as the floppy drive or optical drive), check system setup to ensure the boot sequence is correct for the devices installed on your computer. • If the problem persists, contact Dell (see "Contacting Dell" on page 66).

Light Pattern	Problem Description	Suggested Resolution
	The computer is in standby mode.	Press a key on the keyboard, move the mouse, or press the power button to resume normal operation.

ELIMINATE INTERFERENCE — Some possible causes of interference are:

- Power, keyboard, and mouse extension cables
- Too many devices connected to the same power strip
- Multiple power strips connected to the same electrical outlet

Memory Problems

 **CAUTION:** Before working inside your computer, read the safety information that shipped with your computer. For additional safety best practices information, see www.dell.com/regulatory_compliance.

IF YOU RECEIVE AN INSUFFICIENT MEMORY MESSAGE —

- Save and close any open files and exit any open programs you are not using to see if that resolves the problem.
- See the software documentation for minimum memory requirements. If necessary, install additional memory.
- Reseat the memory modules to ensure that your computer is successfully communicating with the memory.
- Run the Dell Diagnostics (see "Dell Diagnostics" on page 49).

IF YOU EXPERIENCE OTHER MEMORY PROBLEMS —

- Reseat the memory modules to ensure that your computer is successfully communicating with the memory.
- Ensure that you are following the memory installation guidelines.
- Ensure that the memory you are using is supported by your computer. For more information about the type of memory supported by your computer, see "Specifications" on page 29.
- Run the Dell Diagnostics (see "Dell Diagnostics" on page 49).

Lockups and Software Problems



NOTE: The procedures in this document were written for the Windows default view, so they may not apply if you set your Dell computer to the Windows Classic view.

The computer does not start up

Ensure that the power cable is firmly connected to the computer and to the electrical outlet

A program stops responding

END THE PROGRAM —

- 1 Press <Ctrl><Shift><Esc> simultaneously to access the Task Manager, and click the **Applications** tab.
- 2 Click to select the program that is no longer responding, and click **End Task**.

A program crashes repeatedly



NOTE: Most software includes installation instructions in its documentation or on a floppy disk, CD, or DVD.

CHECK THE SOFTWARE DOCUMENTATION — If necessary, uninstall and then reinstall the program.

A program is designed for an earlier Microsoft® Windows® operating system

RUN THE PROGRAM COMPATIBILITY WIZARD —

- 1 Click Start  → Control Panel → Programs → Use an older program with this version of Windows.
- 2 In the welcome screen, click **Next**.
- 3 Follow the instructions on the screen.

A solid blue screen appears

TURN THE COMPUTER OFF — If you are unable to get a response by pressing a key on your keyboard or moving your mouse, press and hold the power button for at least 6 seconds (until the computer turns off), and then restart your computer.

Other software problems

CHECK THE SOFTWARE DOCUMENTATION OR CONTACT THE SOFTWARE MANUFACTURER FOR TROUBLESHOOTING INFORMATION —

- Ensure that the program is compatible with the operating system installed on your computer.
- Ensure that your computer meets the minimum hardware requirements needed to run the software. See the software documentation for information.
- Ensure that the program is installed and configured properly.
- Verify that the device drivers do not conflict with the program.
- If necessary, uninstall and then reinstall the program.

Dell Technical Update Service

The Dell Technical Update service provides proactive e-mail notification of software and hardware updates for your computer. To enroll for the Dell Technical Update service, go to support.dell.com/technicalupdate.

Dell Diagnostics



CAUTION: Before you begin any of the procedures in this section, follow the safety instructions that shipped with your computer.

Starting the Dell Diagnostics From Your Hard Drive

- 1 Ensure that the computer is connected to a working electrical outlet.
- 2 Turn on (or restart) your computer.
- 3 When the DELL™ logo appears, press <F12> immediately. Select Diagnostics from the start menu and press <Enter>.



NOTE: If you wait too long and the operating system logo appears, continue to wait until you see the Microsoft® Windows® desktop, and then shut down your computer and try again.



NOTE: If you see a message stating that no diagnostics utility partition has been found, run the Dell Diagnostics from the *Drivers and Utilities* media.

- 4 Press any key to start the Dell Diagnostics from the diagnostics utility partition on your hard drive, and follow the instructions on the screen.

Starting the Dell Diagnostics From the Dell *Drivers and Utilities* Media

 **NOTE:** The Dell *Drivers and Utilities* media is optional and may not ship with your computer.

- 1 Insert the *Drivers and Utilities* media.
- 2 Shut down and restart the computer.

When the DELL logo appears, press <F12> immediately.

 **NOTE:** If you wait too long and the operating system logo appears, continue to wait until you see the Microsoft® Windows® desktop; then, shut down your computer and try again.

 **NOTE:** The next steps change the boot sequence for one time only. On the next start-up, the computer starts according to the devices specified in the system setup program.

- 3 When the boot device list appears, highlight CD/DVD/CD-RW and press <Enter>.
- 4 Select the **Boot from CD-ROM** option from the menu that appears and press <Enter>.
- 5 Type 1 to start the CD menu and press <Enter> to proceed.
- 6 Select **Run the 32 Bit Dell Diagnostics** from the numbered list. If multiple versions are listed, select the version that is appropriate for your computer.
- 7 When the Dell Diagnostics **Main Menu** appears, select the test that you want to run, and follow the instructions on the screen.

Reinstalling Software

Drivers

Identifying Drivers

- 1 Locate the list of devices for your computer.
 - a Click the Windows Vista Start button , and right-click **Computer**.
 - b Click **Properties**→ **Device Manager**.
- 2 Scroll down the list to see if any device has an exclamation point (a yellow circle with a [!]) on the device icon.



NOTE: The **User Account Control** window may appear. If you are an administrator on the computer, click **Continue**; otherwise, contact your administrator to continue.

If an exclamation point is next to the device name, you may need to reinstall the driver or install a new driver (see "Reinstalling Drivers and Utilities" on page 51).

Reinstalling Drivers and Utilities



NOTE: The Dell Support website at support.dell.com and your *Drivers and Utilities* media provide approved drivers for your computer. If you install drivers obtained from other sources, your computer might not work correctly.

Returning to a Previous Device Driver Version

- 1 Click the Windows Vista Start button , and right-click **Computer**.
- 2 Click **Properties**→ **Device Manager**.



NOTE: The **User Account Control** window may appear. If you are an administrator on the computer, click **Continue**; otherwise, contact your administrator to enter the Device Manager.

- 3 Right-click the device for which the new driver was installed and click **Properties**.
- 4 Click the **Drivers** tab→ **Roll Back Driver**.

If Device Driver Rollback does not resolve the problem, use System Restore (see "Restoring Your Operating System" on page 53) to return your computer to the operating state that existed before you installed the new driver.

Using the Drivers and Utilities Media

Before using the *Drivers and Utilities* media, try the following:

- Windows Device Driver Rollback (see "Returning to a Previous Device Driver Version" on page 52)
- Microsoft System Restore (see "Using Microsoft® Windows® System Restore" on page 54)

- 1 With the Windows desktop displayed, insert your *Drivers and Utilities* media.

If this is your first time using the *Drivers and Utilities* media, go to step 2. If not, go to step 5.

- 2 When the *Drivers and Utilities* media installation program starts, follow the prompts on the screen.



NOTE: In most cases, the *Drivers and Utilities* program starts running automatically. If it does not, start Windows Explorer, click your media drive directory to display the media contents, and then double-click the **autorcd.exe** file.

- 3 When the **InstallShield Wizard Complete** window appears, remove the *Drivers and Utilities* media and click **Finish** to restart the computer.
- 4 When you see the Windows desktop, reinsert the *Drivers and Utilities* media.

- 5 At the **Welcome Dell System Owner** screen, click **Next**.

The drivers that are used by your computer are automatically displayed in the **My Drivers—The ResourceCD has identified these components in your system** window.

- 6 Click the driver that you want to reinstall and follow the instructions on the screen.

If a particular driver is not listed, that driver is not required by your operating system, or you must find the drivers that came with the specific device.

Manually Reinstalling Drivers

- 1 Click the Windows Vista Start button , and right-click **Computer**.
- 2 Click **Properties**→ **Device Manager**.



NOTE: The **User Account Control** window appears. If you are an administrator on the computer, click **Continue**; otherwise, contact your administrator to enter the **Device Manager**.

- 3 Double-click the type of device for which you are installing the driver (for example, **Audio** or **Video**).
- 4 Double-click the name of the device for which you are installing the driver.
- 5 Click the **Driver** tab→ **Update Driver**→ **Browse my computer for driver software**.
- 6 Click **Browse** and browse to the location to which you previously copied the driver files.
- 7 Click the name of the driver→ **OK**→ **Next**.
- 8 Click **Finish** and restart your computer.

Restoring Your Operating System

You can restore your operating system in the following ways:

- Microsoft Windows System Restore returns your computer to an earlier operating state without affecting data files. Use System Restore as the first solution for restoring your operating system and preserving data files.

- Dell Factory Image Restore returns your hard drive to the same operating state as when you purchased the computer. The program deletes all data on the hard drive and removes any programs installed after you received the computer.
- If you received the *Operating System* media with your computer, you can use it to restore your operating system. However, using the *Operating System* media deletes all data on the hard drive.

Using Microsoft® Windows® System Restore



NOTE: The procedures in this document were written for the Windows default view, so they may not apply if you set your Dell™ computer to the Windows Classic view.

Starting System Restore

- 1 Click Start .
- 2 In the Start Search box, type `System Restore` and press <Enter>.



NOTE: The User Account Control window may appear. If you are an administrator on the computer, click **Continue**; otherwise, contact your administrator to continue the desired action.

- 3 Click **Next** and follow the remaining prompts on the screen.

Undoing the Last System Restore



NOTICE: Before you undo the last system restore, save and close all open files and exit any open programs. Do not alter, open, or delete any files or programs until the system restoration is complete.

- 1 Click Start .
- 2 In the Start Search box, type `System Restore` and press <Enter>.
- 3 Click **Undo my last restoration** and click **Next**.

Using Dell Factory Image Restore



NOTICE: Use Dell Factory Image Restore only if System Restore did not resolve your operating system problem. Using Dell Factory Image Restore permanently deletes all data (for example, documents, spreadsheets, e-mail messages, digital

photos, and music files) on the hard drive and removes any programs or drivers installed after you received your computer. If possible, back up the data before using Dell Factory Image Restore.



NOTE: Dell Factory Image Restore may not be available in certain countries or on certain computers.

- 1 Turn on the computer.
- 2 When the Dell logo appears, press <F8> several times to access the **Vista Advanced Boot Options** window.
- 3 Select **Repair Your Computer**.
The **System Recovery Options** window appears.
- 4 Select a keyboard layout and click **Next**.
- 5 To access the recovery options, log on as a local user.
- 6 To access the command prompt, type `administrator` in the **User name** field, then click **OK**.
- 7 Click **Dell Factory Image Restore**.



NOTE: Depending upon your configuration, you may need to select **Dell Factory Tools**, then **Dell Factory Image Restore**.

- 8 On the **Dell Factory Image Restore** welcome screen, click **Next**.
The **Confirm Data Deletion** screen appears.



NOTICE: If you do not want to proceed with Factory Image Restore, click **Cancel**.

- 9 Click the checkbox to confirm that you want to continue reformatting the hard drive and restoring the system software to the factory condition, then click **Next**.

The restore process begins and may take 5 or more minutes to complete. A message appears when the operating system and factory-installed applications have been restored to factory condition.

- 10 Click **Finish** to restart the computer.

Using the Operating System Media

Before reinstalling the operating system, try the following:

- Windows Device Driver Rollback (see "Returning to a Previous Device Driver Version" on page 52)

- Microsoft System Restore (see "Using Microsoft® Windows® System Restore" on page 54)

 **NOTICE:** Before performing the installation, back up all data files from your primary hard drive to another media. For conventional hard drive configurations, the primary hard drive is the first drive detected by the computer.

To reinstall Windows, you need the Dell™ *Operating System* media and the Dell *Drivers and Utilities* media. The Dell *Drivers and Utilities* media contains drivers that were installed at the time you ordered your computer.

 **NOTE:** Depending on the region from which you ordered your computer, or whether you requested the media, the Dell Drivers and Utilities media and Dell Operating System media may not ship with your computer.

Reinstalling Windows

 **NOTE:** The reinstallation process can take 1 to 2 hours to complete.

- 1 Save and close any open files and exit any open programs.
- 2 Insert the *Operating System* media.
- 3 If the `Install windows` message appears, click **Exit**.
- 4 Restart the computer, and when the DELL logo appears, press <F12> immediately.

If you wait too long and the operating system logo appears, wait until you see the Microsoft® Windows® desktop; then, restart your computer and try again.

- 5 When the boot device list appears, highlight **CD/DVD/CD-RW Drive** and press <Enter>.

This selection changes the boot sequence for one time only.

- 6 Press any key to **Boot from CD-ROM**, and follow the instructions on the screen to complete the installation.
- 7 Reinstall the device drivers, virus protection program, and other software.

Finding Information



NOTE: Some features or media may be optional and may not ship with your computer. Some features or media may not be available in certain countries.



NOTE: Additional information may ship with your computer.

Document/Media/Label	Contents
<p>Service Tag/Express Service Code</p> <p>The <i>Service Tag/Express Service Code</i> is located on your computer.</p>	<ul style="list-style-type: none"> • Use the Service Tag to identify your computer when you use support.dell.com or contact support. • Enter the Express Service Code to direct your call when contacting support <p>NOTE: Your Service Tag/Express Service Code is located on your computer.</p>
<p>Drivers and Utilities Media</p> <p>The <i>Drivers and Utilities</i> media is a CD or DVD that may have shipped with your computer.</p>	<ul style="list-style-type: none"> • A diagnostic program for your computer • Drivers for your computer <p>NOTE: Drivers and documentation updates can be found at support.dell.com.</p> <ul style="list-style-type: none"> • Desktop System Software (DSS) • Readme files <p>NOTE: Readme files may be included on your media to provide last-minute updates about technical changes to your computer or advanced technical-reference material for technicians or experienced users.</p>
<p>Operating System Media</p> <p>The <i>Operating System</i> media is a CD or DVD that may have shipped with your computer.</p>	<p>Reinstall your operating system</p>

Document/Media/Label	Contents
<p>Safety, Regulatory, Warranty, and Support Documentation</p> <p>This type of information may have shipped with your computer. For additional regulatory information, see the Regulatory Compliance Homepage on www.dell.com at the following location: www.dell.com/regulatory_compliance.</p>	<ul style="list-style-type: none"> • Warranty information • Terms and Conditions (U.S. only) • Safety instructions • Regulatory information • Ergonomics information • End User License Agreement
<p>Service Manual</p> <p>The <i>Service Manual</i> for your computer can be found at support.dell.com.</p>	<ul style="list-style-type: none"> • How to remove and replace parts • How to configure system settings • How to troubleshoot and solve problems
<p>Dell Technology Guide</p> <p>The <i>Dell Technology Guide</i> is available at support.dell.com.</p>	<ul style="list-style-type: none"> • About your operating system • Using and maintaining devices • Understanding technologies such as RAID, Internet, Bluetooth[®] wireless technology, e-mail, networking, and more.
<p>Dell[™] Systems Management Administrator's Guide</p> <p>The <i>Dell Systems Management Administrator's Guide</i> is available at support.dell.com.</p>	<ul style="list-style-type: none"> • About Intel[®] Active Management Technology (iAMT[®]), including overview, features, setup, and configuration information. • Location of drivers for iAMT.
<p>Microsoft[®] Windows[®] License Label</p> <p>Your Microsoft Windows License is located on your computer.</p>	<ul style="list-style-type: none"> • Provides your operating system product key.

Getting Help

Obtaining Assistance

 **CAUTION:** If you need to remove the computer cover, first disconnect the computer power and modem cables from all electrical outlets. Follow the safety instructions that shipped with your computer.

If you experience a problem with your computer, you can complete the following steps to diagnose and troubleshoot the problem:

- 1 See "Tips" on page 39 for information and procedures that pertain to the problem your computer is experiencing.
- 2 See "Dell Diagnostics" on page 49 for procedures on how to run Dell Diagnostics.
- 3 Fill out the "Diagnostics Checklist" on page 65.
- 4 Use Dell's extensive suite of online services available at Dell Support (support.dell.com) for help with installation and troubleshooting procedures. See "Online Services" on page 61 for a more extensive list of Dell Support online.
- 5 If the preceding steps have not resolved the problem, see "Contacting Dell" on page 66.



NOTE: Call Dell Support from a telephone at or near the affected computer so that the support staff can assist you with any necessary procedures.



NOTE: Dell's Express Service Code system may not be available in all countries.

When prompted by Dell's automated telephone system, enter your Express Service Code to route the call directly to the proper support personnel. If you do not have an Express Service Code, open the **Dell Accessories** folder, double-click the **Express Service Code** icon, and follow the directions.

For instructions on using the Dell Support, see "Technical Support and Customer Service" on page 61.



NOTE: Some of the following services are not always available in all locations outside the continental U.S. Call your local Dell representative for information on availability.

Fast Call for Help

If your system administrator has configured your system with Intel® Active Management Technology (iAMT), help can be obtained by using Fast Call for Help. Fast Call for Help alerts the IT department to your problem and allows IT to take control of your system so they can fix it remotely.

To initiate a Fast Call for Help session using iAMT 5.0 with your IT department, follow these steps.

- 1 Ensure that the computer is connected to a working electrical outlet and network connection.
- 2 Turn on (or restart) your computer.
- 3 When the Dell™ logo appears, press <ctrl><h>.

Loading iAMT drivers on installation

To enable Intel AMT (iAMT) system management, download the following Intel drivers:

- AMT HECI
- AMT SOL/LMS

To download these drivers:

- 1 Navigate to support.dell.com.
- 2 Select **Drivers and Downloads**.
- 3 Select your product model and follow the instructions. The AMT HECI and AMT SOL/LMS drivers can be downloaded from the **Chipset** category.

After downloading the drivers, you are ready to configure your computer to take advantage of the Intel iAMT management capabilities. For information on setting up and configuring your computer for Intel iAMT management:

- 1 Navigate to support.dell.com.
- 2 Select **Manuals**.
- 3 Locate the instructions for your system.

- 4 Select Dell™ Systems Management Administrator's Guide for Intel iAMT setup and configuration information.

Technical Support and Customer Service

Dell's support service is available to answer your questions about Dell™ hardware. Our support staff uses computer-based diagnostics to provide fast, accurate answers.

To contact Dell's support service, see "Before You Call" on page 64, and then see the contact information for your region or go to support.dell.com.

DellConnect™

DellConnect is a simple online access tool that allows a Dell service and support associate to access your computer through a broadband connection, diagnose your problem and repair it all under your supervision. For more information, go to support.dell.com and click **DellConnect**.

Online Services

You can learn about Dell products and services at the following websites:

www.dell.com

www.dell.com/ap (Asian/Pacific countries only)

www.dell.com/jp (Japan only)

www.euro.dell.com (Europe only)

www.dell.com/la (Latin American and Caribbean countries)

www.dell.ca (Canada only)

You can access Dell Support through the following websites and e-mail addresses:

- Dell Support websites:
support.dell.com
support.jp.dell.com (Japan only)
support.euro.dell.com (Europe only)

- Dell Support e-mail addresses:
mobile_support@us.dell.com
support@us.dell.com
la-techsupport@dell.com (Latin America and Caribbean countries only)
apsupport@dell.com (Asian/Pacific countries only)
- Dell Marketing and Sales e-mail addresses:
apmarketing@dell.com (Asian/Pacific countries only)
sales_canada@dell.com (Canada only)
- Anonymous file transfer protocol (FTP):
ftp.dell.com – log in as user **anonymous**, and use your e-mail address as your password

AutoTech Service

Dell's automated support service—AutoTech—provides recorded answers to the questions most frequently asked by Dell customers about their laptop and desktop computers.

When you call AutoTech, use your touch-tone telephone to select the subjects that correspond to your questions. For the telephone number to call for your region, see "Contacting Dell" on page 66.

Automated Order-Status Service

To check on the status of any Dell products that you have ordered, you can go to **support.dell.com**, or you can call the automated order-status service. A recording prompts you for the information needed to locate and report on your order. For the telephone number to call for your region, see "Contacting Dell" on page 66.

Problems With Your Order

If you have a problem with your order, such as missing parts, wrong parts, or incorrect billing, contact Dell for customer assistance. Have your invoice or packing slip available when you call. For the telephone number to call for your region, see "Contacting Dell" on page 66.

Product Information

If you need information about additional products available from Dell, or if you would like to place an order, visit the Dell website at www.dell.com. For the telephone number to call for your region or to speak to a sales specialist, see "Contacting Dell" on page 66.

Returning Items for Warranty Repair or Credit

Prepare all items being returned, whether for repair or credit, as follows:

- 1** Call Dell to obtain a Return Material Authorization Number, and write it clearly and prominently on the outside of the box.
For the telephone number to call for your region, see "Contacting Dell" on page 66. Include a copy of the invoice and a letter describing the reason for the return.
- 2** Include a copy of the Diagnostics Checklist (see "Diagnostics Checklist" on page 65), indicating the tests that you have run and any error messages reported by the Dell Diagnostics (see "Contacting Dell" on page 66).
- 3** Include any accessories that belong with the item(s) being returned (power cables, software floppy disks, guides, and so on) if the return is for credit.
- 4** Pack the equipment to be returned in the original (or equivalent) packing materials.

You are responsible for paying shipping expenses. You are also responsible for insuring any product returned, and you assume the risk of loss during shipment to Dell. Collect On Delivery (C.O.D.) packages are not accepted.

Returns that are missing any of the preceding requirements will be refused at Dell's receiving dock and returned to you.

Before You Call



NOTE: Have your Express Service Code ready when you call. The code helps Dell's automated-support telephone system direct your call more efficiently. You may also be asked for your Service Tag (located on the back or bottom of your computer).

Remember to fill out the Diagnostics Checklist (see "Diagnostics Checklist" on page 65). If possible, turn on your computer before you call Dell for assistance and call from a telephone at or near the computer. You may be asked to type some commands at the keyboard, relay detailed information during operations, or try other troubleshooting steps possible only at the computer itself. Ensure that the computer documentation is available.



CAUTION: Before working inside your computer, follow the safety instructions in the documentation that shipped with your computer.

Diagnostics Checklist

Name:

Date:

Address:

Phone number:

Service Tag (bar code on the back or bottom of the computer):

Express Service Code:

Return Material Authorization Number (if provided by Dell support technician):

Operating system and version:

Devices:

Expansion cards:

Are you connected to a network? Yes No

Network, version, and network adapter:

Programs and versions:

See your operating system documentation to determine the contents of the system's start-up files. If the computer is connected to a printer, print each file. Otherwise, record the contents of each file before calling Dell.

Error message, beep code, or diagnostic code:

Description of problem and troubleshooting procedures you performed:

Contacting Dell

For customers in the United States, call 800-WWW-DELL (800-999-3355).



NOTE: If you do not have an active Internet connection, you can find contact information on your purchase invoice, packing slip, bill, or Dell product catalog.

Dell provides several online and telephone-based support and service options. Availability varies by country and product, and some services may not be available in your area. To contact Dell for sales, technical support, or customer service issues:

- 1 Visit support.dell.com, and verify your country or region in the **Choose A Country/Region** drop-down menu at the bottom of the page.
- 2 Click **Contact Us** on the left side of the page, and select the appropriate service or support link based on your need.
- 3 Choose the method of contacting Dell that is convenient for you.

Index

C

- Client Initiated Remote Access, 60
- connecting
 - Internet, 24
 - modem, 19
 - monitor, 18
 - network, 21
 - network cable, 19
 - power cables, 20
- contacting Dell, 59, 66

D

- Dell
 - contacting, 59, 66
 - software updates, 49
 - Support Utility, 49
 - technical support and customer service, 61
 - Technical Update Service, 49
- Dell Diagnostics, 49
 - starting from the Drivers and Utilities media, 50
 - starting from your hard drive, 49
- Dell Systems Management Administrator's Guide, 58

- Dell Technology Guide, 58
- DellConnect, 61
- Desktop System Software, 57
- diagnostics
 - Dell, 49
- documentation, 57
 - Dell Systems Management Administrator's Guide, 58
 - Dell Technology Guide, 58
 - Service Manual, 58
- drivers, 51
 - Drivers and Utilities media, 57
 - identifying, 51
 - reinstalling, 51
 - returning to a previous version, 52
- Drivers and Utilities media, 52, 57
 - Dell Diagnostics, 49

E

- End User License Agreement (EULA), 58
- ergonomics information, 58
- Express Service Code, 57

F

- Fast Call for Help, 60
- Files and Settings Transfer Wizard, 25
- finding information, 57

I

- Intel Active Management Technology (iAMT)
 - documentation, 58
 - enabling, 60
 - Fast Call for Help, 60
- Internet
 - connecting, 24
 - setting up, 24

L

- license label, 58

M

- media
 - Drivers and Utilities, 57
 - operating system, 57
- memory
 - troubleshooting, 47

N

- networks, 21
 - connecting, 21

O

- operating system
 - Dell Factory Image Restore, 54
 - media, 55
 - reinstalling, 57
 - System Restore, 53
- Operating System media, 57
- operating system product key, 58

P

- phone numbers, 66
- power
 - power light conditions, 39
 - troubleshooting, 39
- problems
 - restore to previous state, 54

R

- regulatory information, 58
- reinstalling
 - drivers and utilities, 51
 - software, 51

S

- safety information, 58
- Service Manual, 58
- Service Tag, 57
- setup
 - computer, 17
 - installing your computer in an enclosure, 22
 - Internet, 24
 - quick setup, 17
- software
 - problems, 48
 - reinstalling, 51
 - troubleshooting, 48-49
 - updates, 49
- specifications
 - all, 29
 - audio, 30
 - connectors, 33
 - controls and lights, 34
 - drives, 32
 - environmental, 37
 - expansion bus, 30
 - memory, 29
 - physical, 36
 - power, 35
 - processor, 29
 - system information, 29
 - video, 30
- support, 59
 - contacting Dell, 66
 - DellConnect, 61

- support (*continued*)
 - online services, 61
 - regional, 61
 - technical support and customer service, 61
- support information, 58
- System Restore, 53-54

T

- Terms and Conditions, 58
- transferring information to a new computer, 25
- troubleshooting, 39, 58
 - blue screen, 48
 - computer not responding, 48
 - Dell Diagnostics, 49
 - memory, 47
 - power, 39
 - power light conditions, 39
 - program crashes, 48
 - programs and Windows compatibility, 48
 - restore to previous state, 53-54
 - software, 48-49
 - tips, 39

U

- updates
 - software and hardware, 49

V

view

- back, 8, 14
- back panel connectors, 7-9
- front, 7

W

warranty information, 58

Windows License label, 58

Windows Vista

- Dell Factory Image Restore, 54
- Device Driver Rollback, 52
- Program Compatibility wizard, 48
- reinstalling, 57
- returning to a previous device
 - driver version, 52
- System Restore, 53-54

Windows XP

- Files and Settings Transfer Wizard, 25
- reinstalling, 57
- System Restore, 53-54

wizards

- Files and Settings Transfer Wizard, 25
- Program Compatibility wizard, 48